

## Features

- Compatible with all I<sup>2</sup>C bidirectional data transfer protocol
- Memory array:
  - 64 Kbits (8 Kbytes) of EEPROM
  - Page size: 32 bytes
- Single supply voltage and high speed:
  - 1.7V-3.6V
  - 1 MHz
- Random and sequential Read modes
- Write:
  - Byte Write within 3 ms
  - Page Write within 3 ms
- Partial Page Writes Allowed
- Write Protect Pin for Hardware Data Protection
- Schmitt Trigger, Filtered Inputs for Noise Suppression
- High-reliability
  - Endurance: 1 Million Write Cycles
  - Data Retention: 100 Years
- Enhanced ESD/Latch-up protection
  - HBM 4000V
- 8-lead PDIP/SOP/TSSOP/UDFN/SOT23-5 and TSOT23-5 packages

## Description

- The BL24C64F provides 65536 bits of serial electrically erasable and programmable read-only memory (EEPROM), organized as 8192 words of 8 bits each.
- The device is optimized for use in many industrial and commercial applications where low-power and low-voltage operation are essential.

## Pin Configuration

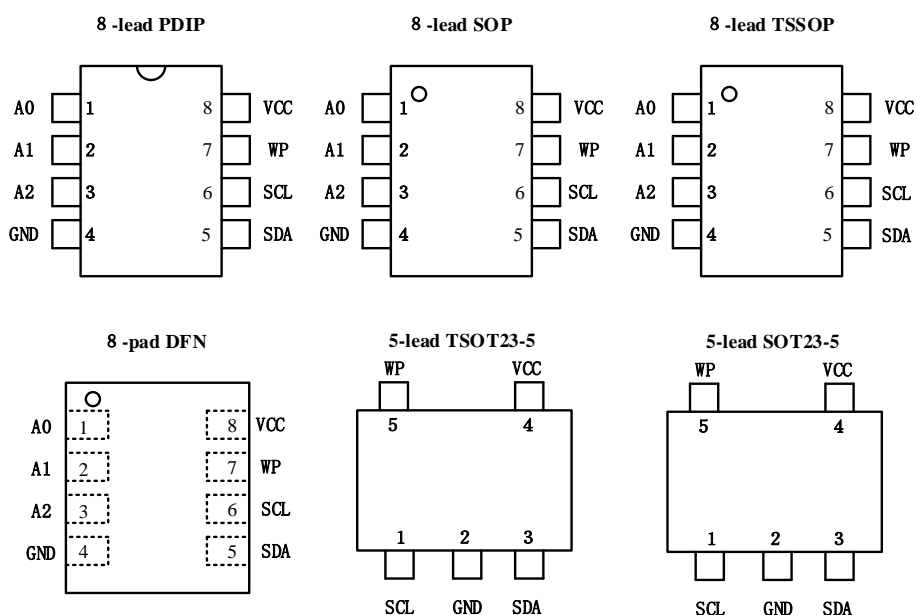



**DEVICE/PAGE ADDRESSES (A2, A1 and A0):** The A2, A1 and A0 pins are device address inputs that are hard wire for the BL24C64F. Eight 64K devices may be addressed on a single bus system (device addressing is discussed in detail under the Device Addressing section).

**SERIAL DATA (SDA):** The SDA pin is bi-directional for serial data transfer. This pin is open-drain driven and may be wire-ORed with any number of other open-drain or open-collector devices.

**SERIAL CLOCK (SCL):** The SCL input is used to positive edge clock data into each EEPROM device and negative edge clock data out of each device.

**WRITE PROTECT (WP):** The BL24C64F has a Write Protect pin that provides hardware data protection. The Write Protect pin allows normal read/write operations when connected to ground (GND). When the Write Protection pin is connected to Vcc, the write protection feature is enabled and operates as shown in the following Table 2.

| WP Pin Status      | BL24C64F                     |
|--------------------|------------------------------|
| At V <sub>CC</sub> | Full(64K) Array              |
| At GND             | Normal Read/Write Operations |

Table 2

## Functional Description

### 1. Memory Organization

BL24C64F, 64K SERIAL EEPROM: Internally organized with 256 pages of 32 bytes each, the 64K requires a 13-bit data word address for random word addressing.

### 2. Device Operation

**CLOCK and DATA TRANSITIONS:** The SDA pin is normally pulled high with an external device. Data on the SDA pin may change only during SCL low time periods (see Figure 2). Data changes during SCL high periods will indicate a start or stop condition as defined below.

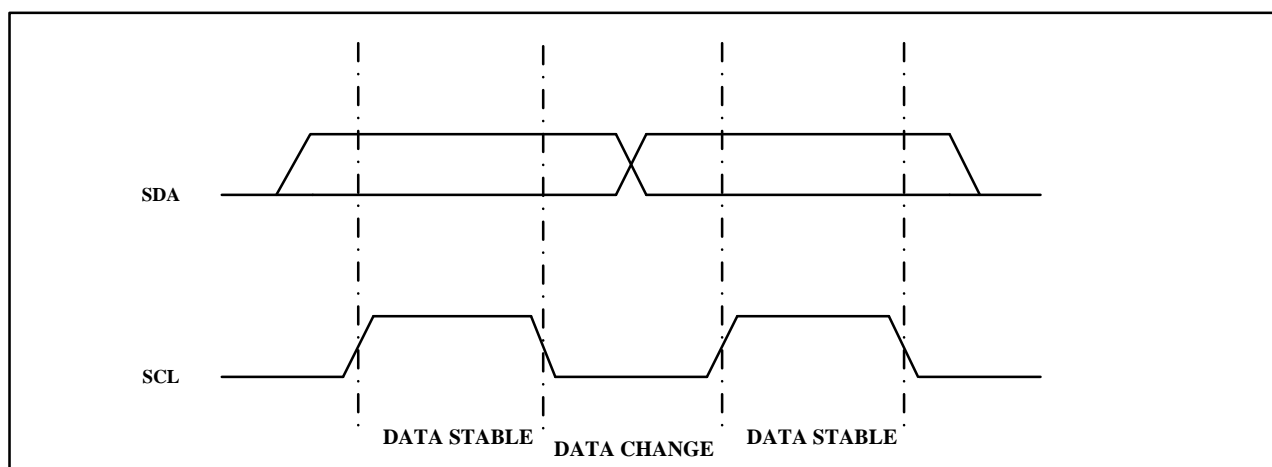

Figure 2. Data Validity

**START CONDITION:** A high-to-low transition of SDA with SCL high is a start condition which must precede any other command (see **Figure 3**).

**STOP CONDITION:** A low-to-high transition of SDA with SCL high is a stop condition. After a read sequence, the stop command will place the EEPROM in a standby power mode (see **Figure 3**).

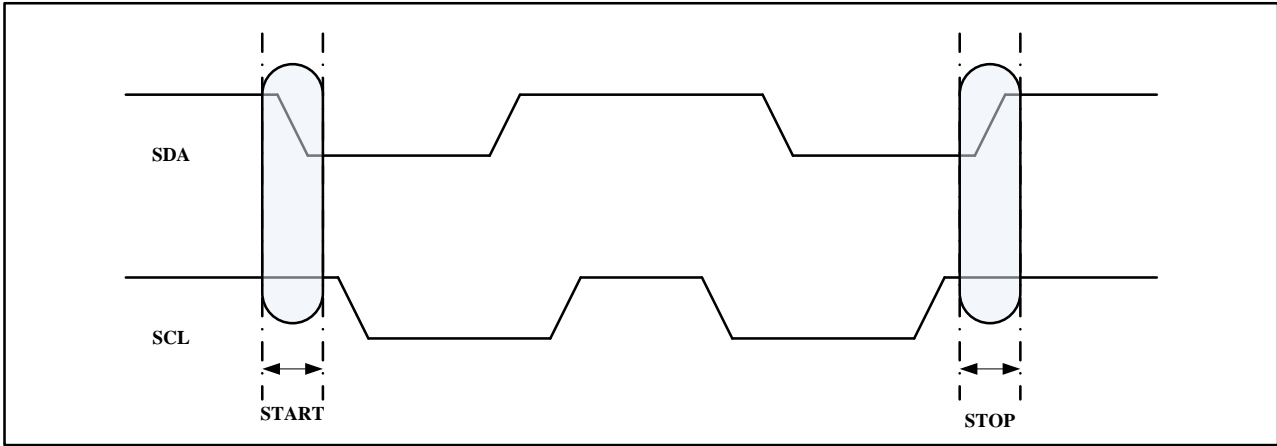

Figure 3. Start and Stop Definition

**ACKNOWLEDGE:** All addresses and data words are serially transmitted to and from the EEPROM in 8-bit words. The EEPROM sends a "0" to acknowledge that it has received each word. This happens during the ninth clock cycle.

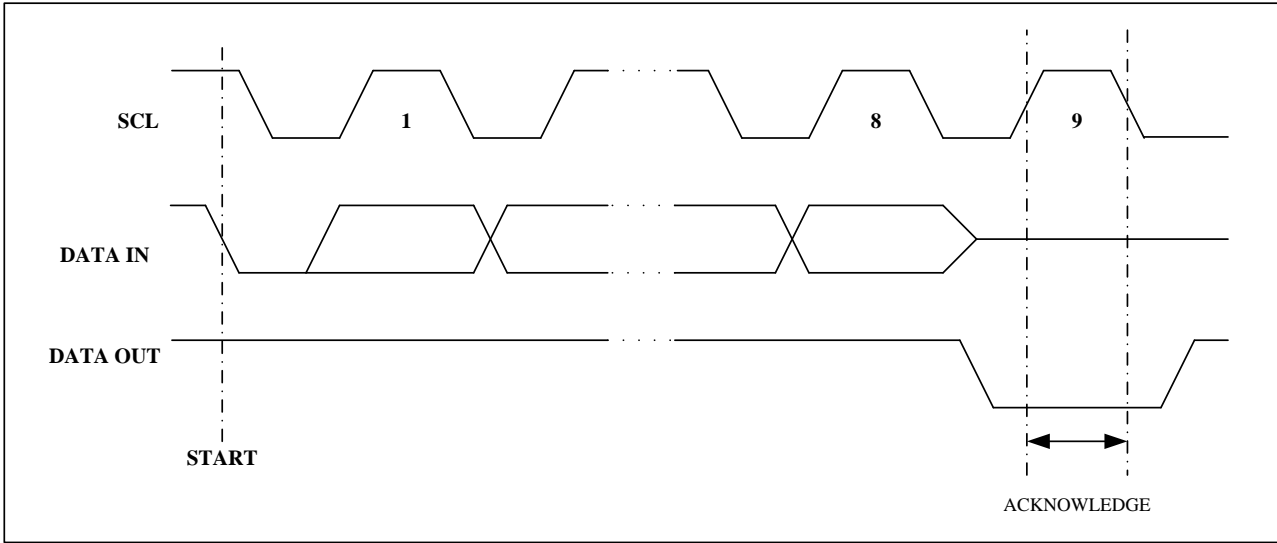

Figure 4. Output Acknowledge

**STANDBY MODE:** The BL24C64F features a low-power standby mode which is enabled: (a) upon power-up and (b) after the receipt of the STOP bit and the completion of any internal operations.

**MEMORY RESET:** After an interruption in protocol, power loss or system reset, any two-wire part can be reset by following these steps:

1. Clock up to 9 cycles.
2. Lock SDA high in each cycle while SCL is high.
3. Create a start condition.

**3. Device Addressing**

The 64K EEPROM devices all require an 8-bit device address word following a start condition to enable the chip for a read or write operation (see **Figure 5**)

|            |          |          |          |            |           |           |            |
|------------|----------|----------|----------|------------|-----------|-----------|------------|
| <b>MSB</b> |          |          |          | <b>LSB</b> |           |           |            |
| <b>1</b>   | <b>0</b> | <b>1</b> | <b>0</b> | <b>A2</b>  | <b>A1</b> | <b>A0</b> | <b>R/W</b> |

Figure 5. Device Address

The device address word consists of a mandatory "1", "0" sequence for the first four most significant bits as shown. This is common to all the Serial EEPROM devices.

The 64K EEPROM uses A2, A1 and A0 device address bits to allow as much as eight devices on the same bus. These 3 bits must be compared to their corresponding hardwired input pins. The A2, A1 and A0 pins use an internal proprietary circuit that biases them to a logic low condition if the pins are allowed to float.

The eighth bit of the device address is the read/write operation select bit. A read operation is initiated if this bit is high and a write operation is initiated if this bit is low.

Upon a compare of the device address, the EEPROM will output a "0". If a compare is not made, the chip will return to a standby state.

DATA SECURITY: The BL24C64F has a hardware data protection scheme that allows the user to write protect the entire memory when the WP pin is at Vcc.

**4. Write Operations**

BYTE WRITE: A write operation requires two 8-bit data word address (see **Figure 6**) following the device address word and acknowledgment. Upon receipt of this address, the EEPROM will again respond with a "0" and then clock in the first 8-bit data word. Following receipt of the 8-bit data word, the EEPROM will output a "0" and the addressing device, such as a microcontroller, must terminate the write sequence with a stop condition. At this time the EEPROM enters an internally timed write cycle, tWR, to the nonvolatile memory. All inputs are disabled during this write cycle and the EEPROM will not respond until the write is complete (see **Figure 7**).

|            |            |            |            |            |            |           |           |
|------------|------------|------------|------------|------------|------------|-----------|-----------|
| <b>B15</b> | <b>B14</b> | <b>B13</b> | <b>B12</b> | <b>B11</b> | <b>B10</b> | <b>B9</b> | <b>B8</b> |
| <b>B7</b>  | <b>B6</b>  | <b>B5</b>  | <b>B4</b>  | <b>B3</b>  | <b>B2</b>  | <b>B1</b> | <b>B0</b> |

Figure 6. Data Word Address

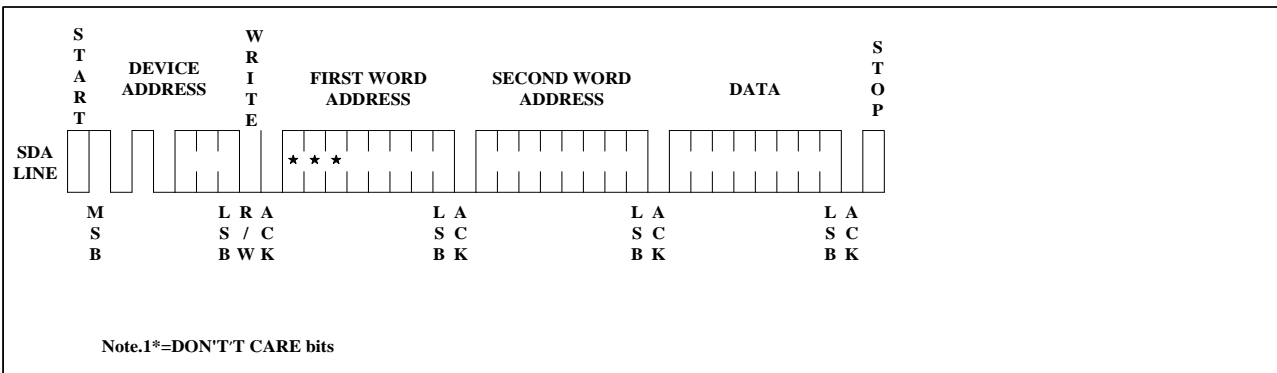

Figure 7. Byte Write

PAGE WRITE: The Page Write mode allows up to 32 bytes to be written in a single Write cycle. A page write is initiated the same as a byte write, but the microcontroller does not send a stop condition after the first data word

is clocked in. Instead, after the EEPROM acknowledges receipt of the first data word, the microcontroller can transmit up to 31 more data words. The EEPROM will respond with a "0" after each data word received. The microcontroller must terminate the page write sequence with a stop condition (see **Figure 8**).

The data word address lower five bits are internally incremented following the receipt of each data word. The higher data word address bits are not incremented, retaining the memory page row location. When the word address, internally generated, reaches the page boundary, the following byte is placed at the beginning of the same page. If more than 32 data words are transmitted to the EEPROM, the data word address will "roll over" and previous data will be overwritten.

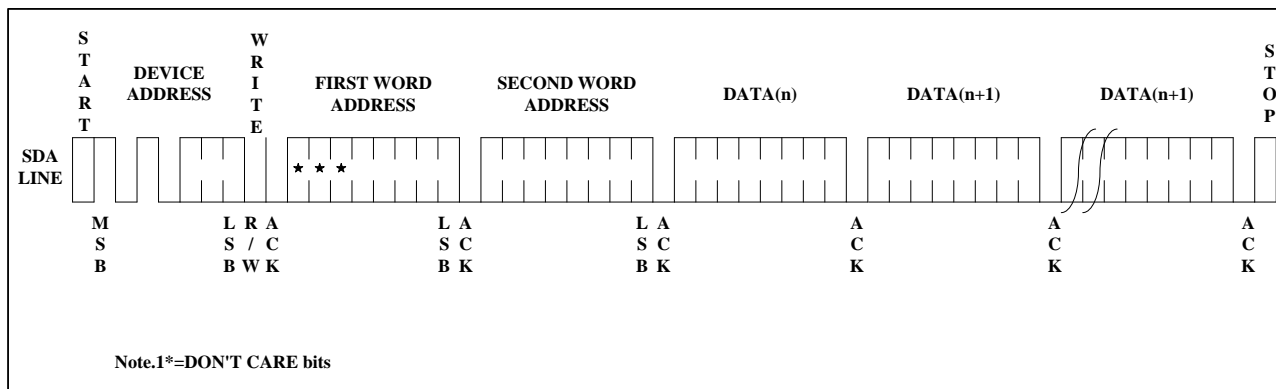

Figure 8. Page Write

**ACKNOWLEDGE POLLING:** Once the internally timed write cycle has started and the EEPROM inputs are disabled, acknowledge polling can be initiated. This involves sending a start condition followed by the device address word. The read/write bit is representative of the operation desired. Only if the internal write cycle has completed will the EEPROM respond with a "0", allowing the read or write sequence to continue.

5. Read Operations

Read operations are initiated the same way as write operations with the exception that the read/write select bit in the device address word is set to "1". There are three read operations: current address read, random address read and sequential read.

**CURRENT ADDRESS READ:** The internal data word address counter maintains the last address accessed during the last read or write operation, incremented by one. This address stays valid between operations as long as the chip power is maintained. The address "roll over" during read is from the last byte of the last memory page to the first byte of the first page. The address "roll over" during write is from the last byte of the current page to the first byte of the same page. Once the device address with the read/write select bit set to "1" is clocked in and acknowledged by the EEPROM, the current address data word is serially clocked out. The microcontroller does not respond with an input "0" but does generate a following stop condition (see **Figure 9**).

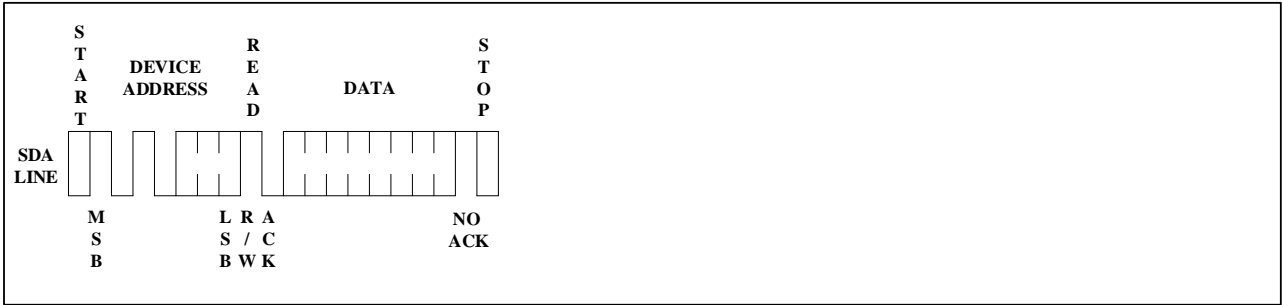

Figure 9. Current Address Read

**RANDOM READ:** A random read requires a "dummy" byte write sequence to load in the data word address. Once the device address word and data word address are clocked in and acknowledged by the EEPROM, the microcontroller must generate another start condition. The microcontroller now initiates a current address read by sending a device address with the read/write select bit high. The EEPROM acknowledges the device address and serially clocks out the data word. The microcontroller does not respond with a "0" but does generate a following stop condition (see **Figure 10**).

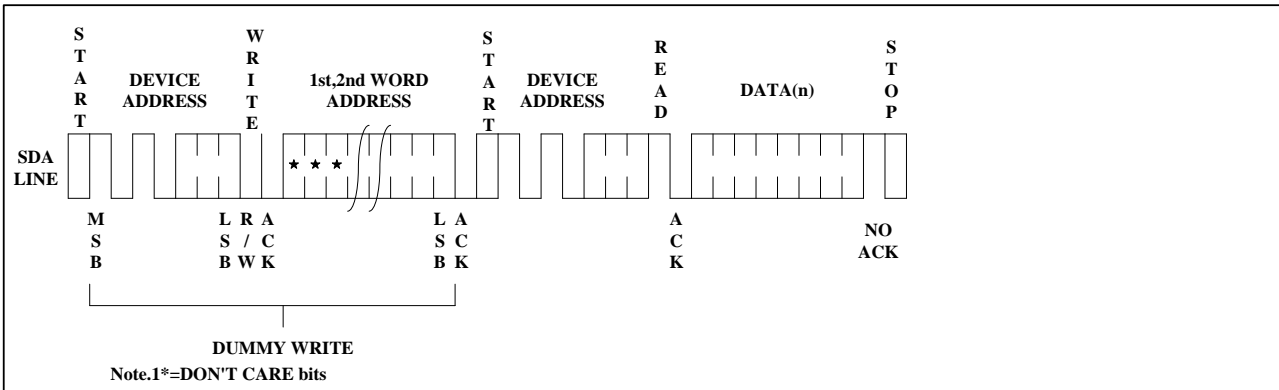

Figure 10. Random Read

SEQUENTIAL READ: Sequential reads are initiated by either a current address read or a random address read. After the microcontroller receives a data word, it responds with an acknowledge. As long as the EEPROM receives an acknowledge, it will continue to increment the data word address and serially clock out sequential data words. When the memory address limit is reached, the data word address will "roll over" and the sequential read will continue. The sequential read operation is terminated when the microcontroller does not respond with a "0" but does generate a following stop condition (see **Figure 11**).

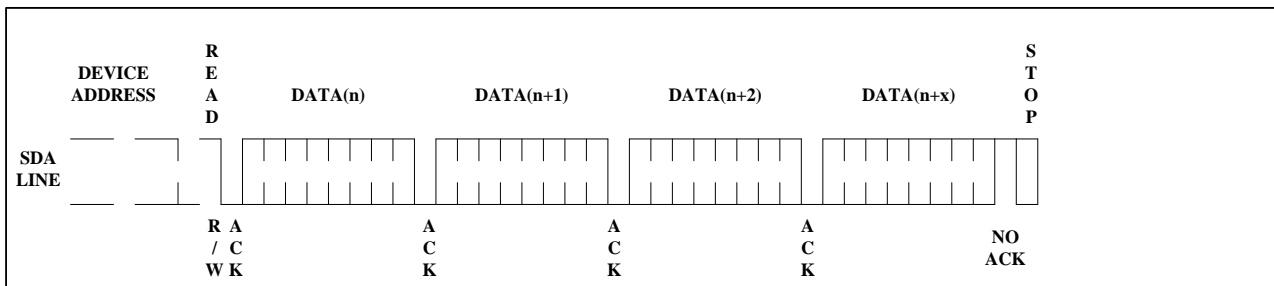

Figure 11. Sequential Read



## Electrical Characteristics

Absolute Maximum Stress Ratings:

- DC Supply Voltage . . . . . -0.3V to +6.5V
- Input / Output Voltage . . . . . GND-0.3V to  $V_{CC}+0.3V$
- Storage Temperature . . . . . -65°C to +150°C
- Electrostatic pulse (Human Body model) . . . . . 4000V

Comments:

Stresses above those listed under "Absolute Maximum Ratings" may cause permanent damage to this device. These are stress ratings only. Functional operation of this device at these or any other conditions above those indicated in the operational sections of this specification is not implied or intended. Exposure to the absolute maximum rating conditions for extended periods may affect device reliability.

### DC Electrical Characteristics

Applicable over recommended operating range from (unless otherwise noted):

| BL24C64F                       | $T_A = -40^{\circ}\text{C}$ to $+85^{\circ}\text{C}$  | $V_{CC} = +1.7V$ to $+3.6V@400\text{kHz}$<br>$V_{CC} = +2.5V$ to $+3.6V@1\text{MHz}$<br>$C_L = 100\text{ pF}$ |      |                    |               |                              |
|--------------------------------|---|---|------|--------------------|---------------|------------------------------|
| BL24C64FE1                     | $T_A = -40^{\circ}\text{C}$ to $+105^{\circ}\text{C}$ |   |      |                    |               |                              |
| BL24C64FE0                     | $T_A = -40^{\circ}\text{C}$ to $+125^{\circ}\text{C}$ |   |      |                    |               |                              |
| Parameter                      | Symbol  | Min   | Typ  | Max                | Unit          | Condition                    |
| Supply Current $V_{CC}=3.6V$   | $I_{RD}$  | -   | 0.14 | 0.3                | mA            | READ at 400kHz               |
| Supply Current $V_{CC}=3.6V$   | $I_{WR}$  | -   | 0.28 | 0.5                | mA            | WRITE at 400kHz              |
| Supply Current $V_{CC}=3.6V$   | $I_{SB}$  | -   | 0.03 | 0.5                | $\mu\text{A}$ | $V_{IN}=V_{CC}$ or $V_{SS}$  |
| Input Leakage Current          | $I_{LI}$  | -   | 0.10 | 1.0                | $\mu\text{A}$ | $V_{IN}=V_{CC}$ or $V_{SS}$  |
| Output Leakage Current         | $I_{LO}$  | -   | 0.05 | 1.0                | $\mu\text{A}$ | $V_{OUT}=V_{CC}$ or $V_{SS}$ |
| Input Low Level                | $V_{IL}$  | -0.3  | -    | $V_{CC}\times 0.3$ | V             | $V_{CC}=1.7V$ to $3.6V$      |
| Input High Level               | $V_{IH}$  | $V_{CC}\times 0.7$  | -    | $V_{CC}+0.3$       | V             | $V_{CC}=1.7V$ to $3.6V$      |
| Output Low Level $V_{CC}=1.7V$ | $V_{OL1}$   | -   | -    | 0.2                | V             | $I_{OL}=0.15\text{mA}$       |
| Output Low Level $V_{CC}=3.6V$ | $V_{OL2}$   | -   | -    | 0.4                | V             | $I_{OL}=3.0\text{mA}$        |

Table 3

### Pin Capacitance

Applicable over recommended operating range from  $T_A = 25^{\circ}\text{C}$ ,  $f = 1.0\text{ MHz}$ ,  $V_{CC} = +1.7V$

| Parameter                       | Symbol    | Min | Typ | Max | Unit | Condition   |
|---------------------------------|-----------|-----|-----|-----|------|-------------|
| Input/Output Capacitance(SDA)   | $C_{I/O}$ | -   | -   | 8   | pF   | $V_{IO}=0V$ |
| Input Capacitance(A0,A1,A2,SCL) | $C_{IN}$  | -   | -   | 6   | pF   | $V_{IN}=0V$ |

Table 4

## AC Electrical Characteristics

| Parameter   | Symbol                           | 1.7V ≤ VCC < 2.5V   |     |     | 2.5V ≤ VCC ≤ 3.6V |     |      | Units       |
|---|----------------------------------|---|-----|-----|-------------------|-----|------|-------------|
|   |                                  | Min   | Typ | Max | Min               | Typ | Max  |             |
| BL24C64F  | T <sub>A</sub> = -40°C to +85°C  | V <sub>CC</sub> = +1.7V to +3.6V@400kHz<br>V <sub>CC</sub> = +2.5V to +3.6V@1MHz<br>C <sub>L</sub> = 100 pF |     |     |                   |     |      |             |
| BL24C64FE1  | T <sub>A</sub> = -40°C to +105°C |   |     |     |                   |     |      |             |
| BL24C64FE0  | T <sub>A</sub> = -40°C to +125°C |   |     |     |                   |     |      |             |
| Clock Frequency,SCL   | f <sub>SCL</sub>                 | -   | -   | 400 | -                 | -   | 1000 | kHz         |
| Clock Pulse Width Low   | t <sub>LOW</sub>                 | 1.3   | -   | -   | 0.5               | -   | -    | μs          |
| Clock Pulse Width High  | t <sub>HIGH</sub>                | 0.6   | -   | -   | 0.26              | -   | -    | μs          |
| Noise Suppression Time  | t <sub>I</sub>                   | -   | -   | 50  | -                 | -   | 50   | ns          |
| Clock Low to Data Out Valid                                   | t <sub>AA</sub>                  | -   | -   | 0.9 | -                 | -   | 0.45 | μs          |
| Time the bus must be free before a new transmission can start | t <sub>BUF</sub>                 | 1.3   | -   | -   | 0.5               | -   | -    | μs          |
| Start Hold Time   | t <sub>HD:STA</sub>              | 0.6   | -   | -   | 0.25              | -   | -    | μs          |
| Start Setup Time  | t <sub>SU:STA</sub>              | 0.6   | -   | -   | 0.25              | -   | -    | μs          |
| Data In Hold Time   | t <sub>HD:DAT</sub>              | 0   | -   | -   | 0                 | -   | -    | μs          |
| Data in Setup Time  | t <sub>SU:DAT</sub>              | 100   | -   | -   | 100               | -   | -    | ns          |
| Input Rise Time <sup>(1)</sup>                                | t <sub>R</sub>                   | -   | -   | 0.3 | -                 | -   | 0.12 | μs          |
| Input Fall Time <sup>(1)</sup>                                | t <sub>F</sub>                   | -   | -   | 0.3 | -                 | -   | 0.12 | μs          |
| Stop Setup Time   | t <sub>SU:STO</sub>              | 0.6   | -   | -   | 0.25              | -   | -    | μs          |
| Data Out Hold Time  | t <sub>DH</sub>                  | 50  | -   | -   | 50                | -   | -    | ns          |
| Write Cycle Time  | t <sub>WR</sub>                  | -   | 1.9 | 3   | -                 | 1.9 | 3    | ms          |
| 3.6V,25°C,Byte Mode <sup>(1)</sup>                            | Endurance                        | 1M  | -   | -   | 1M                | -   | -    | Write Cycle |

Table 5

## Notes:

- This parameter is characterized and is not 100% tested.
- AC measurement conditions:  
R<sub>L</sub> (connects to V<sub>CC</sub>): 1.3 k  
Input pulse voltages: 0.3 V<sub>CC</sub> to 0.7 V<sub>CC</sub>  
Input rise and fall time: 50 ns  
Input and output timing reference voltages: 0.5 V<sub>CC</sub>  
The value of R<sub>L</sub> should be concerned according to the actual loading on the user's system.

Bus Timing

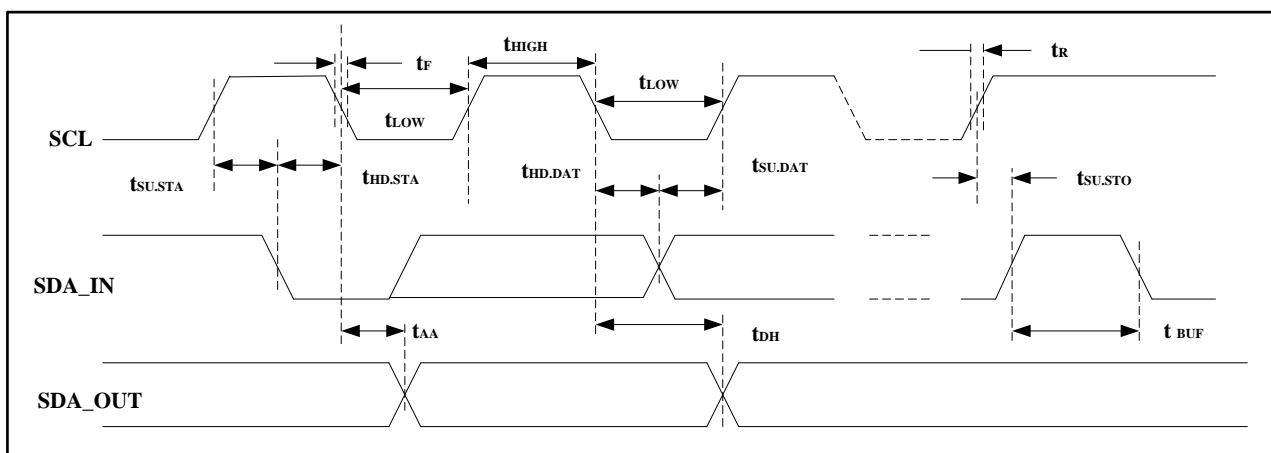

Figure 12. SCL: Serial Clock, SDA: Serial Data I/O

Write Cycle Timing

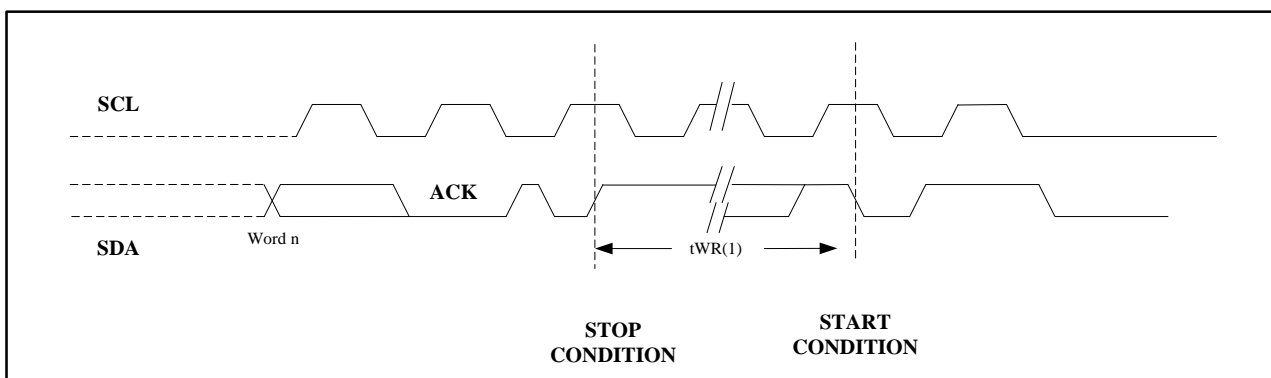

Figure 13. SCL: Serial Clock, SDA: Serial Data I/O

Notes:

The write cycle time  $t_{WR}$  is the time from a valid stop condition of a write sequence to the end of the internal clear/write cycle.

**Package Information**

**PDIP Outline Dimensions**

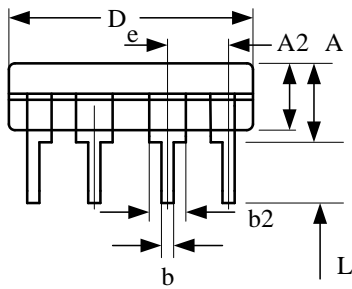
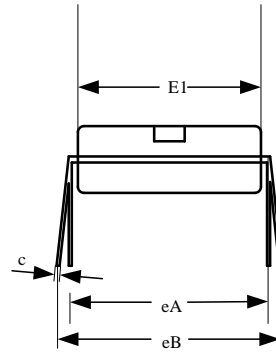
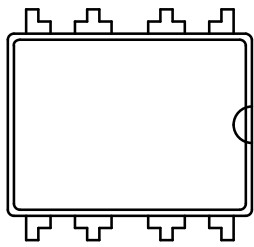

COMMON DIMENSIONS  
 (Unit of Measure=mm)

| SYMBOL | MIN     | NOM  | MAX  |
|--------|---------|------|------|
| A      | 3.60    | 3.80 | 4.00 |
| A2     | 3.20    | 3.30 | 3.40 |
| b      | 0.44    | -    | 0.53 |
| b2     | 1.52BSC |      |      |
| c      | 0.24    | -    | 0.32 |
| D      | 9.05    | 9.25 | 9.45 |
| E1     | 6.15    | 6.35 | 6.55 |
| e      | 2.54BSC |      |      |
| eA     | 7.62BSC |      |      |
| eB     | 7.62    | -    | 9.30 |
| L      | 3.00BSC |      |      |

SOP

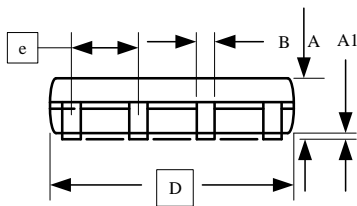
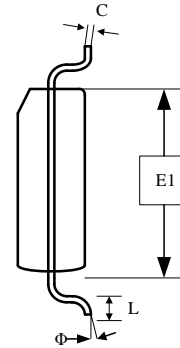
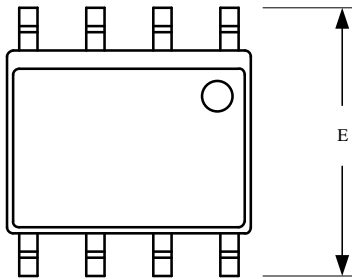

COMMON DIMENSIONS  
 (Unit of Measure=mm)

| SYMBOL | MIN     | NOM  | MAX  |
|--------|---------|------|------|
| A      | 1.35    | -    | 1.75 |
| A1     | 0.10    | -    | 0.23 |
| B      | 0.39    | -    | 0.48 |
| C      | 0.21    | -    | 0.26 |
| D      | 4.70    | 4.90 | 5.10 |
| E1     | 3.70    | 3.90 | 4.10 |
| E      | 5.80    | 6.00 | 6.20 |
| e      | 1.27BSC |      |      |
| L      | 0.50    | -    | 0.80 |
| Φ      | 0"      | -    | 8"   |

TSSOP

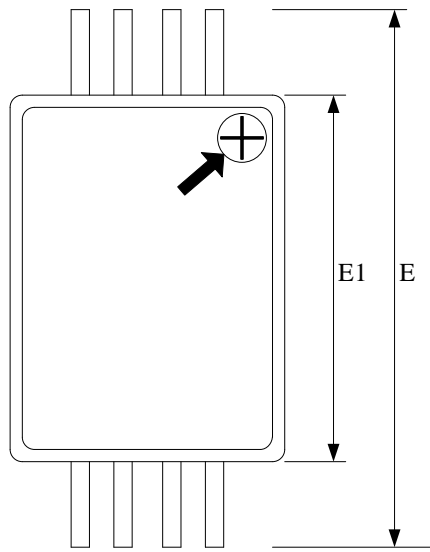

Top View

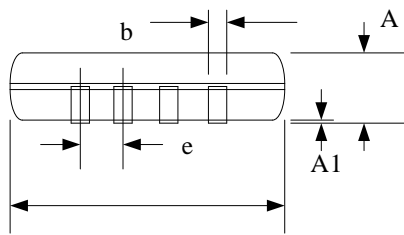

Side View

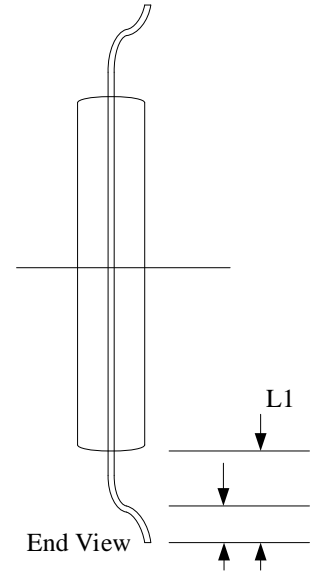

End View

COMMON DIMENSIONS  
 Unit of Measure=mm

| SYMBOL | MIN     | NOM  | MAX  |
|--------|---------|------|------|
| D      | 2.90    | 3.00 | 3.10 |
| E      | 6.20    | 6.40 | 6.60 |
| E1     | 4.30    | 4.40 | 4.50 |
| A      | -       | -    | 1.20 |
| A1     | 0.05    | -    | 0.15 |
| b      | 0.21    | -    | 0.30 |
| e      | 0.65BSC |      |      |
| L      | 0.45    | 0.60 | 0.75 |
| L1     | 1.00REF |      |      |

**UDFN**

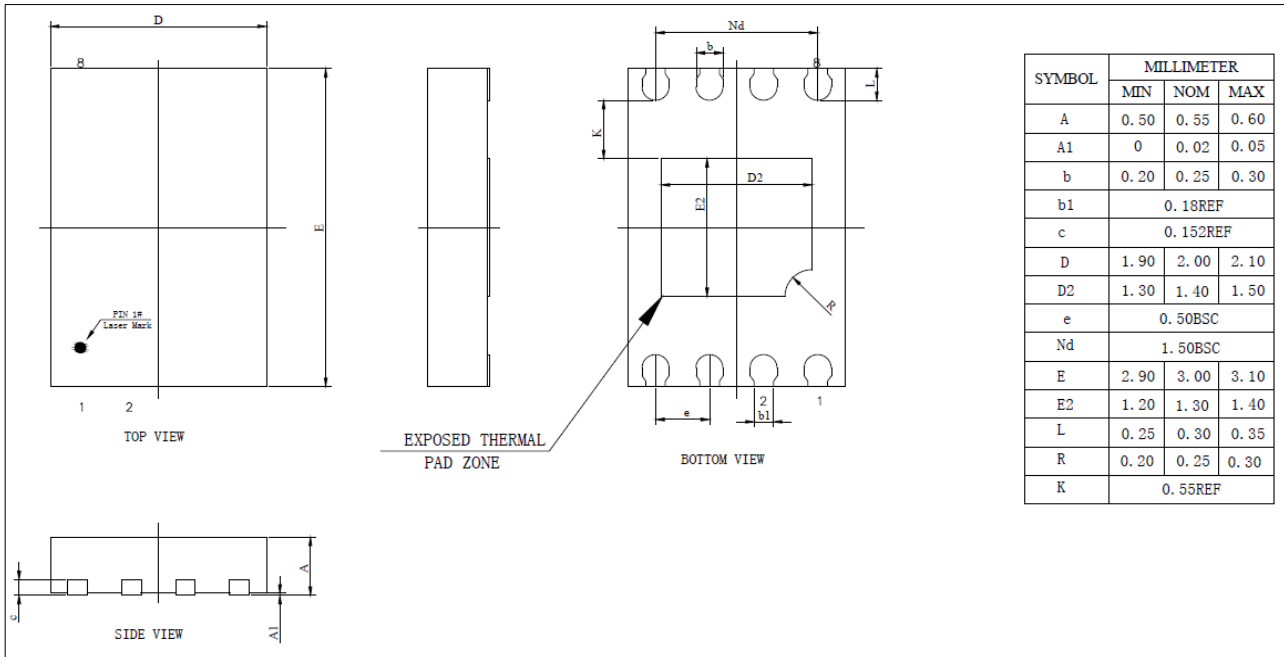

**TSOT23-5**

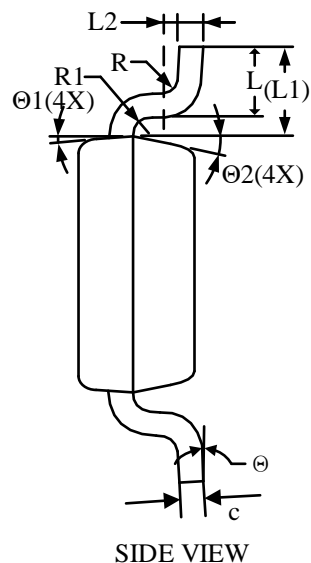
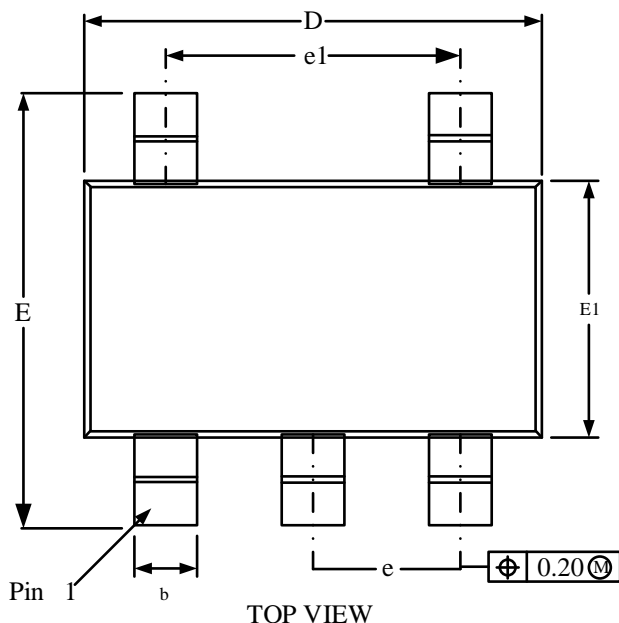

**COMMON DIMENSIONS**  
 (UNITS OF MEASURE = MILLIMETER)

| SYMBOL | MIN      | NOM  | MAX  |
|--------|----------|------|------|
| A      | -        | -    | 0.90 |
| A1     | 0.00     | -    | 0.10 |
| A2     | 0.65     | 0.75 | 0.85 |
| A3     | 0.35     | 0.40 | 0.45 |
| b      | 0.30     | 0.44 | 0.50 |
| c      | 0.14     | -    | 0.20 |
| D      | 2.85     | 2.95 | 3.05 |
| E      | 2.65     | 2.80 | 2.95 |
| E1     | 1.60     | 1.65 | 1.70 |
| e      | 0.90     | 0.95 | 1.00 |
| e1     | 1.80     | 1.90 | 2.00 |
| L      | 0.30     | 0.45 | 0.60 |
| L1     | 0.575REF |      |      |
| L2     | 0.258BSC |      |      |
| R      | -        | -    | 0.25 |
| R1     | -        | -    | 0.25 |
| theta  | 0°       | -    | 8°   |
| theta1 | 3°       | 5°   | 7°   |
| theta2 | 10°      | 12°  | 14°  |

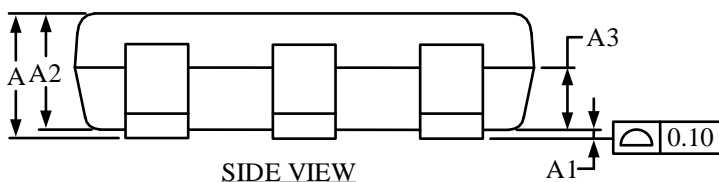



**SOT23-5**

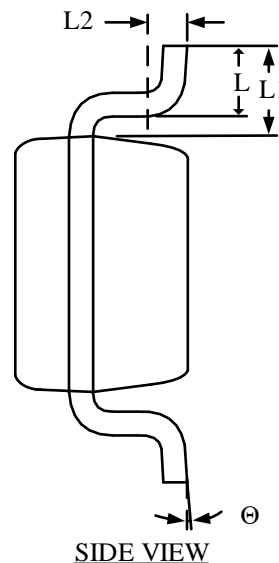
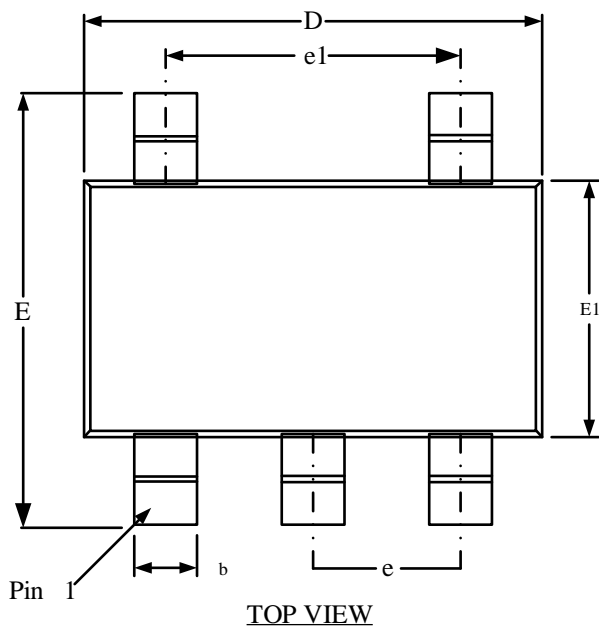

**COMMON DIMENSIONS**  
 (UNITS OF MEASURE = MILLIMETER)

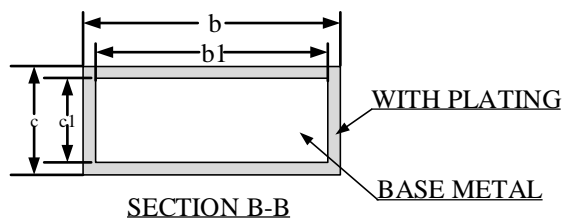
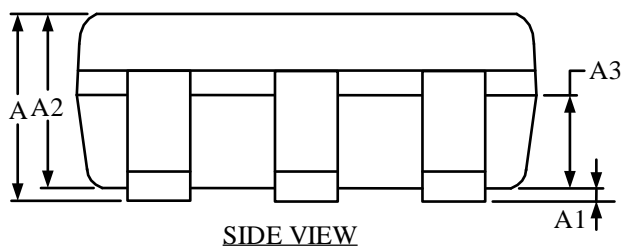

| SYMBOL | MIN      | NOM  | MAX  |
|--------|----------|------|------|
| A      | -        | -    | 1.35 |
| A1     | 0.04     | -    | 0.15 |
| A2     | 1.00     | 1.10 | 1.20 |
| A3     | 0.55     | 0.65 | 0.75 |
| b      | 0.38     | -    | 0.48 |
| b1     | 0.37     | 0.40 | 0.43 |
| c      | 0.11     | -    | 0.21 |
| c1     | 0.10     | 0.13 | 0.16 |
| D      | 2.72     | 2.92 | 3.12 |
| E      | 2.60     | 2.80 | 3.00 |
| E1     | 1.40     | 1.60 | 1.80 |
| e      | 0.95BSC  |      |      |
| e1     | 1.90BSC  |      |      |
| L      | 0.30     | -    | 0.60 |
| L1     | 0.575REF |      |      |
| L2     | 0.258BSC |      |      |
| Θ      | 0°       | -    | 8°   |

### Marking Diagram

**PDIP**

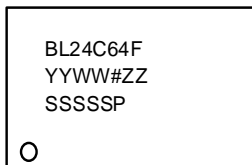

**SOP**

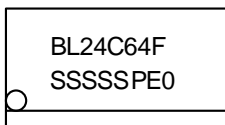

**TSSOP**

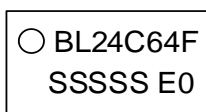

**UDFN**

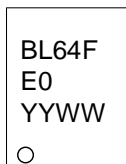

**SOT23-5/TSOT23-5**



|                     |   |
|---------------------|---|
| YY                  | Year  |
| WW                  | Week  |
| ZZ                  | Assembly house  |
| SSSSS               | Lot ID  |
| E0                  | Blank: -40°C to +85°C<br>E1: -40°C to +105°C<br>E0: -40°C to +125°C |
| P(TSOT23-5/SOT23-5) | P: -40°C to +85°C<br>1: -40°C to +105°C<br>0: -40°C to +125°C       |

### Ordering Information

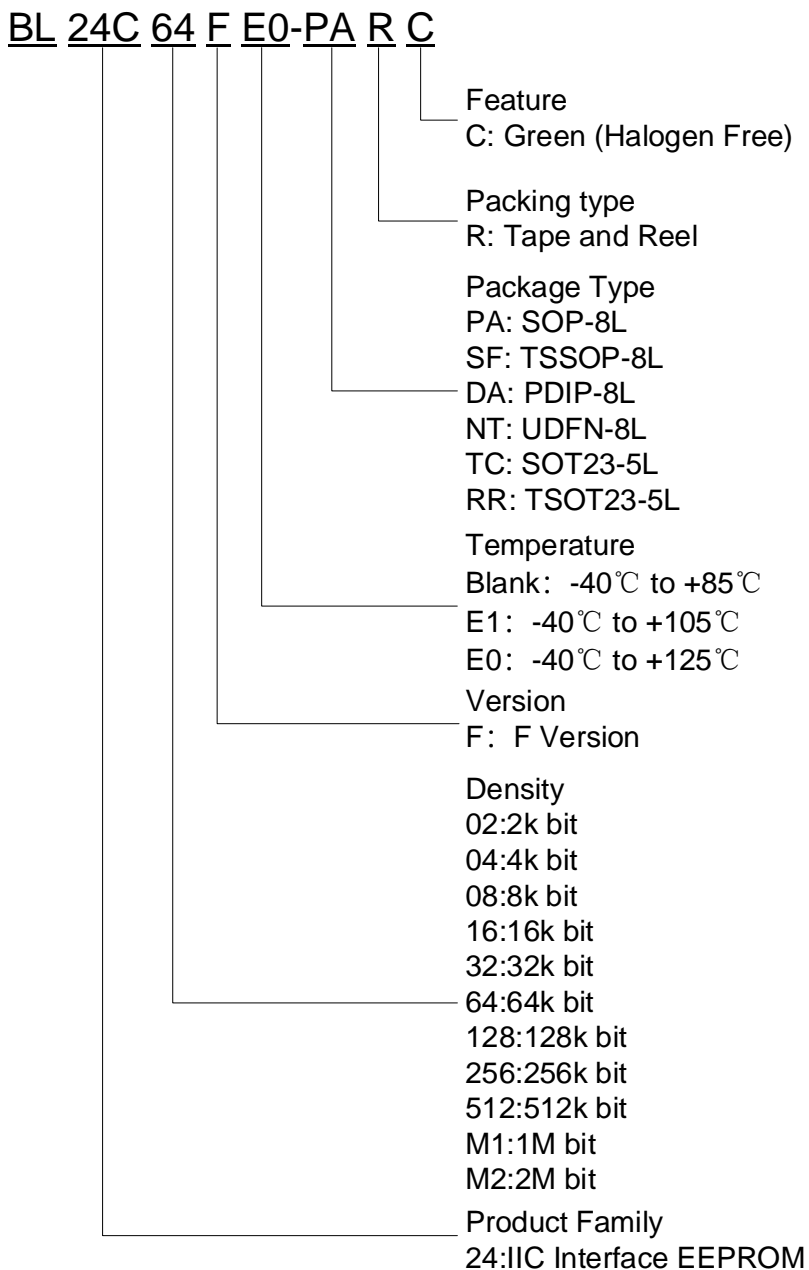

| Device   | Package  | Shipping(Qty/Packing) |
|----------|----------|-----------------------|
| BL24C64F | SOP8     | 2500/Tape &Reel       |
| BL24C64F | TSSOP8L  | 3000/Tape &Reel       |
| BL24C64F | UDFN     | 3000/Tape &Reel       |
| BL24C64F | SOT23-5  | 3000/Tape &Reel       |
| BL24C64F | TSOT23-5 | 3000/Tape &Reel       |

## Revision History

|                              |                   |
|------------------------------|-------------------|
| <b>Version 1.00 BL24C64F</b> | <b>06/06/2023</b> |
| Initial version.             |                   |