

## Features

- Single-Supply Operation from +2.1V ~ +5.5V
- Low Noise :  $6.5\text{nV}/\sqrt{\text{Hz}}$  @1kHz
- Gain-Bandwidth Product: 12MHz (Typ)
- Low Input Bias Current: 1pA (Typ)
- Low Offset Voltage: 0.2mV (Typ)
- High Slew Rate: 11V/ $\mu\text{s}$
- Quiescent Current: 1.1mA per Amplifier (Typ)
- Rail-to-Rail Input / Output
- Operating Temperature: -40°C ~ +125°C
- Small Package:  
 BL3701 Available in SOT23-5 and SC70-5 Packages  
 BL3702 Available in SOP-8, TSSOP8 and MSOP-8 Packages  
 BL3704 Available in SOP-14 and TSSOP-14 Packages

## General Description

BL370X series operates from a single 2.1V to 5.5V supply or dual  $\pm 1.05\text{V}$  to  $\pm 2.75\text{V}$  supplies, The BL370X have a high gain-bandwidth product of 12MHz, a slew rate of 11V/ $\mu\text{s}$ , and a quiescent current of 1.1mA per amplifier at 5V. The BL370X are designed to provide optimal performance in low voltage and low noise systems. The input common mode voltage range includes ground, They are specified over the extended industrial temperature range (-40°C to +125°C). The operating range is from 2.1V to 5.5V. The BL3701 single is available in Green SC70-5 and SOT23-5 packages. The BL3702 dual is available in Green SOP-8, TSSOP8 and MSOP-8 packages. The BL3704 Quad is available in Green SOP-14 and TSSOP-14 packages.

## Applications

- servo motor
- Home appliance control panel
- BMS
- Handheld Test Equipment
- Battery-Powered Instrumentation

## Package/Ordering Information

MODEL	CHANNEL	ORDER NUMBER	PACKAGE DESCRIPTION	PACKAGE OPTION
BL3701	Single	BL3701CR	SC70-5	Tape and Reel,3000
		BL3701ACR	SC70-5	Tape and Reel,3000
		BL3701FR	SOT23-5	Tape and Reel,3000
BL3702	Dual	BL3702SR	SOP-8	Tape and Reel,4000
		BL3702TR	TSSOP-8	Tape and Reel,3000
		BL3702MR	MSOP-8	Tape and Reel,3000
BL3704	Quad	BL3704TR	TSSOP-14	Tape and Reel,3000
		BL3704SR	SOP-14	Tape and Reel,2500

## Pin Configuration

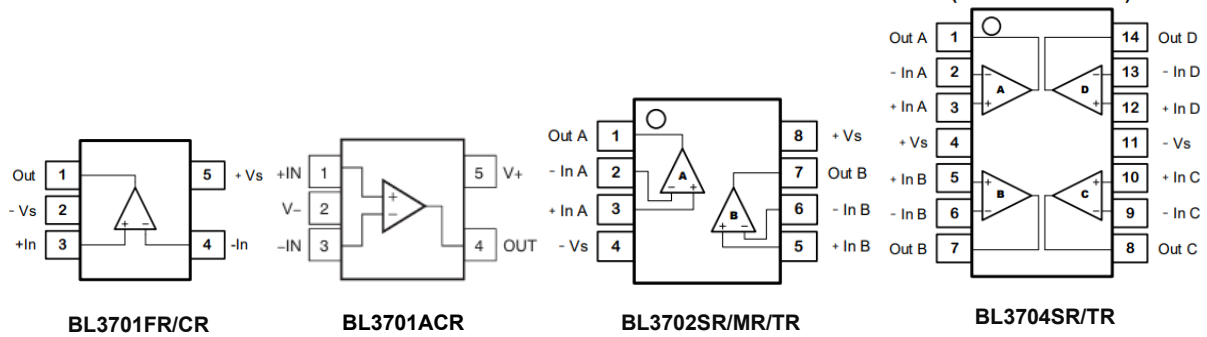

Figure 1. Pin Assignment Diagram

## Absolute Maximum Ratings

Condition	Min	Max
Power Supply Voltage ( $V_{DD}$ to $V_{SS}$ )	-0.5V	+6V
Analog Input Voltage (IN+ or IN-)	$V_{SS}-0.3V$	$V_{DD}+0.5V$
PDB Input Voltage	$V_{SS}-0.3V$	+6V
Operating Temperature Range	-40°C	+125°C
Junction Temperature	+160°C	
Storage Temperature Range	-55°C	+150°C
Lead Temperature (soldering, 10sec)	+260°C	
<b>Package Thermal Resistance (<math>T_A=+25^\circ\text{C}</math>)</b>		
SOP-8, $\theta_{JA}$	125°C/W	
MSOP-8, $\theta_{JA}$	216°C/W	
SOT23-5, $\theta_{JA}$	190°C/W	
SC70-5, $\theta_{JA}$	333°C/W	
<b>ESD Susceptibility</b>		
HBM	2KV	

**ELECTRICAL CHARACTERISTICS**

(At TA = +25°C, VS = +5V, VCM = VS/2, RL = 600Ω, unless otherwise noted.)

PARAMETER	SYMBOL	CONDITIONS	BL3701 /BL3702 /BL3704			
			MIN	TYP	MAX	UNITS
<b>INPUT CHARACTERISTICS</b>						
Input Offset Voltage (BL3701)	V <sub>OS</sub>	V <sub>CM</sub> = V <sub>S</sub> /2	-0.6	±0.2	0.6	mV
Input Offset Voltage (BL3702)	V <sub>OS</sub>	V <sub>CM</sub> = V <sub>S</sub> /2	-0.6	±0.2	0.6	mV
Input Offset Voltage (BL3704)	V <sub>OS</sub>	V <sub>CM</sub> = V <sub>S</sub> /2	-2.5	±0.2	2.5	mV
Input Bias Current	I <sub>B</sub>			1		pA
Input Offset Current	I <sub>OS</sub>			1		pA
Common-Mode Voltage Range	V <sub>CM</sub>	V <sub>S</sub> = 5.5V	(-V <sub>S</sub> ) - 0.1		(+V <sub>S</sub> ) + 0.1	V
Common-Mode Rejection Ratio	CMRR	V <sub>S</sub> = 5.5V, V <sub>CM</sub> = -0.1V to 4V	65	80		dB
		V <sub>S</sub> = 5.5V, V <sub>CM</sub> = -0.1V to 5.6V	60	73		
Open-Loop Voltage Gain	A <sub>OL</sub>	RL = 600Ω, V <sub>OUT</sub> = 0.15V to 4.85V	80	95		dB
		RL = 10kΩ, V <sub>OUT</sub> = 0.05V to 4.95V	95	105		
Input Offset Voltage Drift	ΔV <sub>OS</sub> /ΔT	V <sub>CM</sub> = +V <sub>S</sub> /2, -40°C ≤ TA ≤ +125°C		2		μV/°C
<b>OUTPUT CHARACTERISTICS</b>						
Output Voltage Swing from Rail	V <sub>OH</sub>	RL = 10KΩ	4.995			V
	V <sub>OL</sub>				5	mV
Short Circuit Current	I <sub>SOURCE</sub>	V <sub>S</sub> =5V	95	100		mA
<b>POWER SUPPLY</b>						
Operating Voltage Range			2.1		5.5	V
Power Supply Rejection Ratio	PSRR	V <sub>S</sub> = 2.1V to 5.5V, V <sub>CM</sub> = 0.5V	75	90		dB
Quiescent Current / Amplifier	I <sub>Q</sub>			1.1	1.8	mA
<b>DYNAMIC PERFORMANCE</b>						
Gain-Bandwidth Product	GBP			12		MHZ
Slew Rate	SR	G = +1, 2V Output Step		11		V/μs
Phase Margin	PM	+V <sub>S</sub> = 1.4V to 5.5V		62		°
Full-Power Bandwidth	BWp	<1% distortion		300		KHZ
Settling Time to 0.1%	T <sub>s</sub>	G = 1, 2V output step		0.35		μs
Overload Recovery Time		V <sub>IN</sub> × G = V <sub>S</sub>		0.7		μs
Input Voltage Noise Density	e <sub>n</sub>	f = 1KHZ		6.5		nV/√Hz
		f = 10kHZ		3.5		nV/√Hz

### Typical Performance characteristics

(At  $V_s=5V$ ,  $T_A = +25^\circ C$ ,  $V_{CM} = V_s/2$ ,  $R_L = 10K\Omega$ , unless otherwise noted.)

Supply Current vs. Temperature

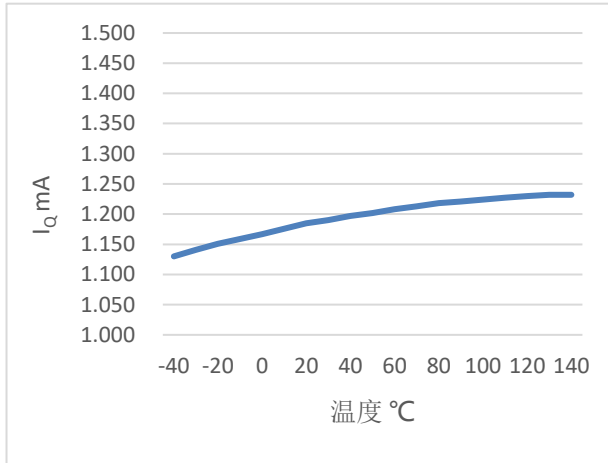

$V_{OS}$  vs. Temperature

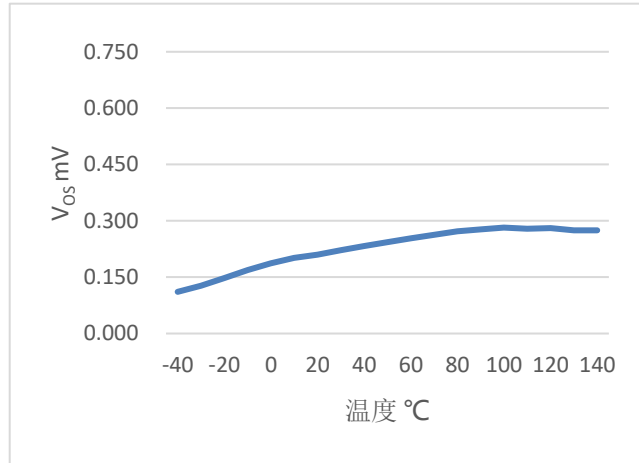

$V_{OH}$  vs. Temperature

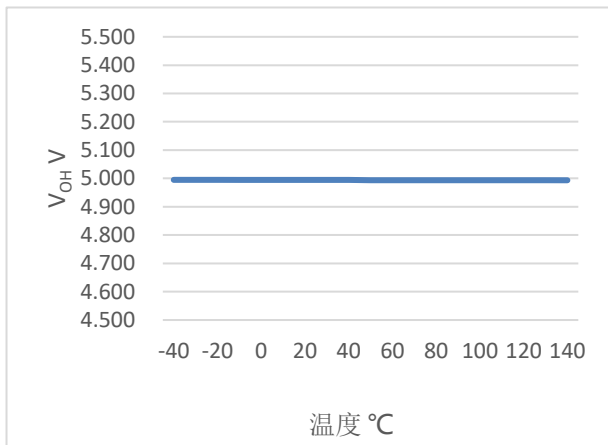

$V_{OL}$  vs. Temperature

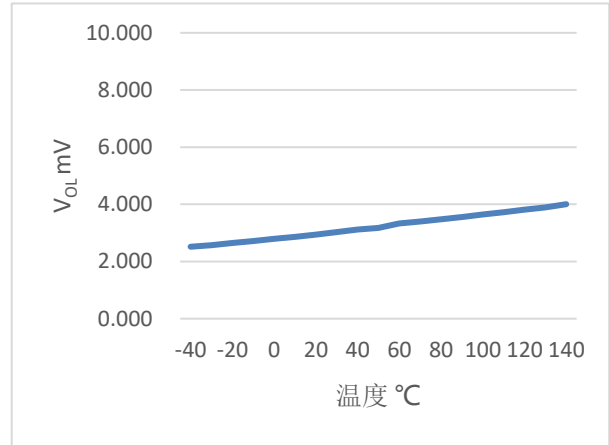

$I_{SINK}$  vs. Temperature

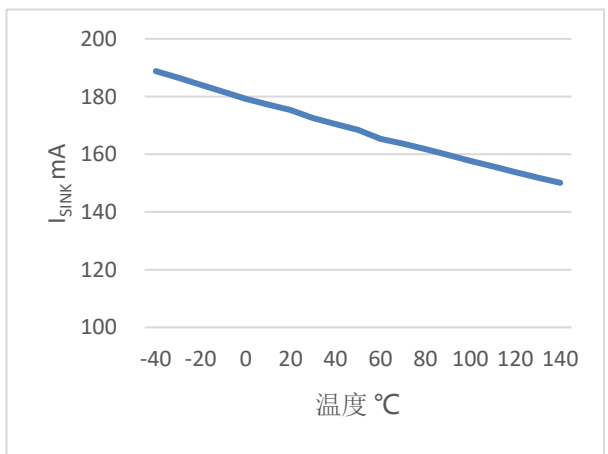

$I_{SOURCE}$  vs. Temperature

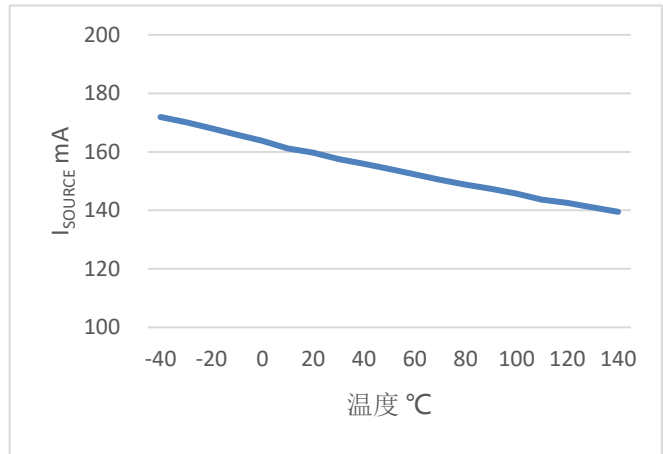

(At  $V_s=5V$ ,  $T_A = +25^\circ C$ ,  $V_{CM} = V_s/2$ ,  $R_L = 600\Omega$ , unless otherwise noted.)

Large-Signal Step Response

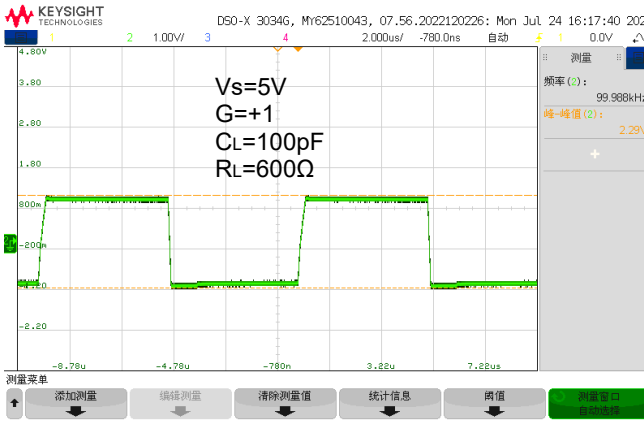

Large-Signal Step Response

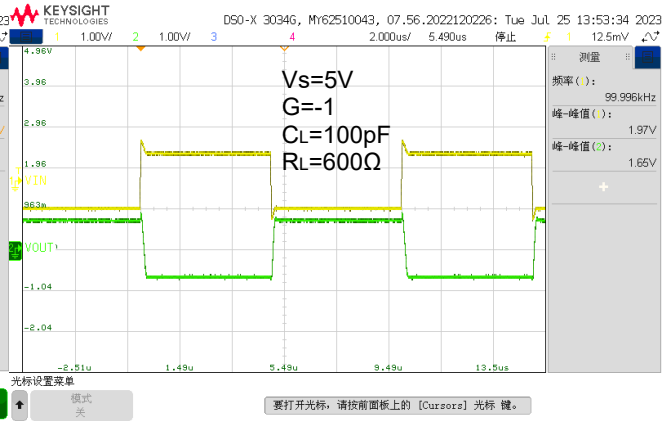

Small-Signal Step Response

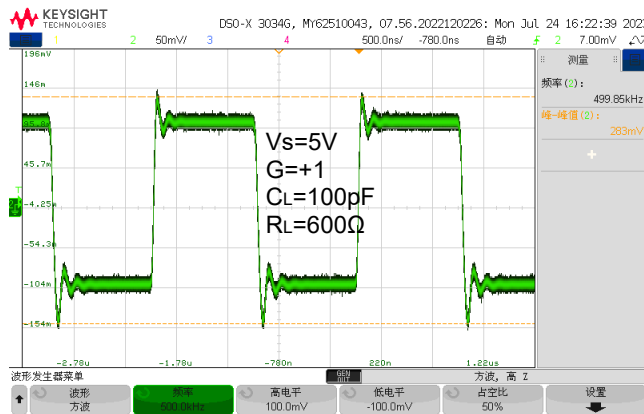

Small-Signal Step Response

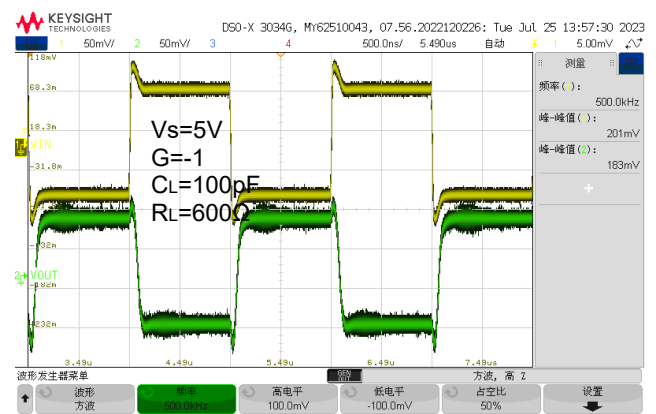

Slew Rate

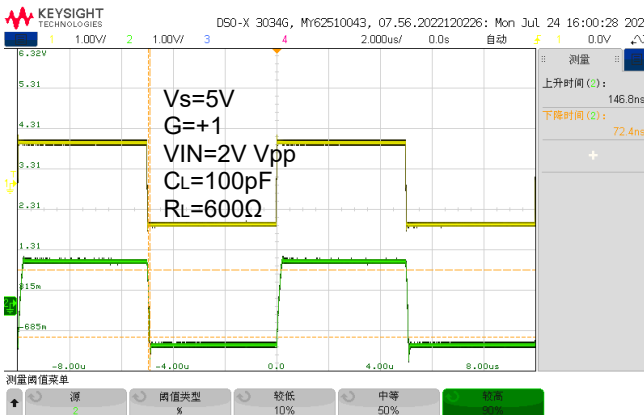

Overload Recovery Time

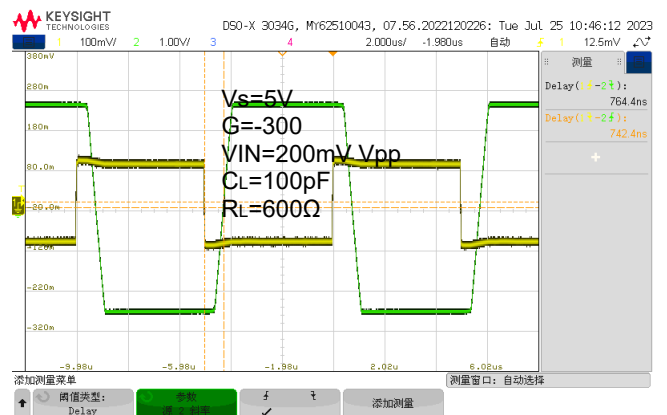

Package Information

MSOP-8

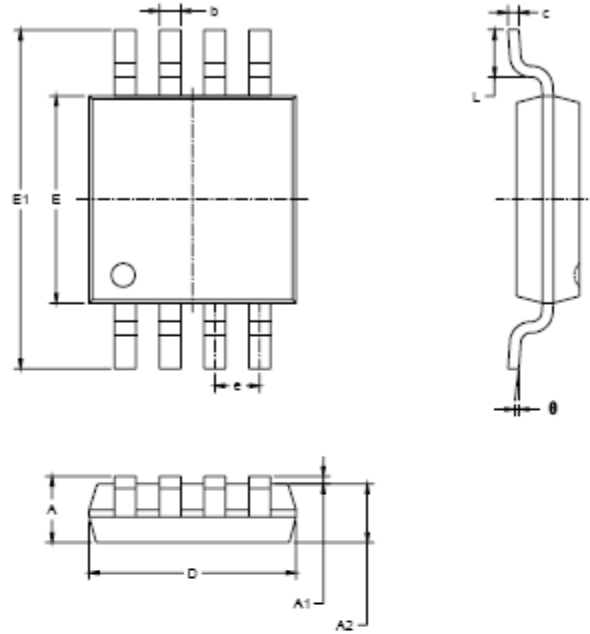

Symbol	Dimensions In Millimeters		Dimensions In Inches	
	MIN	MAX	MIN	MAX
A	0.820	1.100	0.032	0.043
A1	0.020	0.150	0.001	0.006
A2	0.750	0.950	0.030	0.037
b	0.250	0.380	0.010	0.015
c	0.090	0.230	0.004	0.009
D	2.900	3.100	0.114	0.122
E	2.900	3.100	0.114	0.122
E1	4.750	5.050	0.187	0.199
e	0.650 BSC		0.026 BSC	
L	0.400	0.800	0.016	0.031
θ	0°	6°	0°	6°

SOP-8

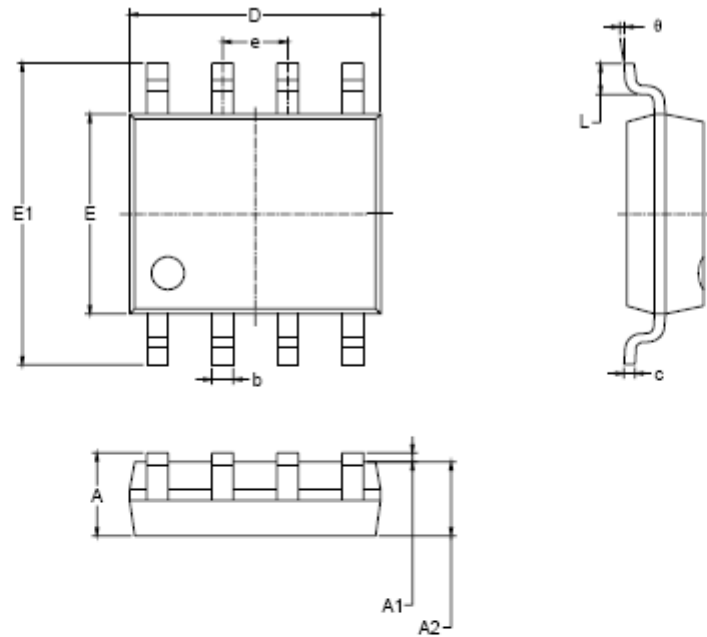

Symbol	Dimensions In Millimeters		Dimensions In Inches	
	MIN	MAX	MIN	MAX
A	1.350	1.750	0.053	0.069
A1	0.100	0.250	0.004	0.010
A2	1.350	1.550	0.053	0.061
b	0.330	0.510	0.013	0.020
c	0.170	0.250	0.006	0.010
D	4.700	5.100	0.185	0.200
E	3.800	4.000	0.150	0.157
E1	5.800	6.200	0.228	0.244
e	1.27 BSC		0.050 BSC	
L	0.400	1.270	0.016	0.050
theta	0°	8°	0°	8°

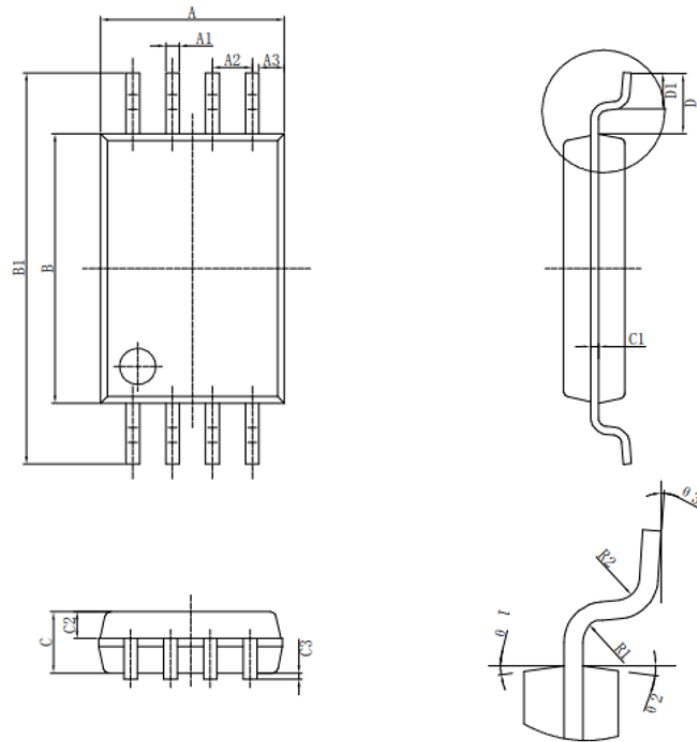
**TSSOP-8**

标注	尺寸	最小(mm)	最大(mm)	标注	尺寸	最小(mm)	最大(mm)
A		2.90	3.10	C3		0.05	0.15
A1		0.20	0.30	D		1.00REF	
A2		0.65 TYP		D1		0.50	0.70
A3		0.36	0.46	R1		0.15TYP	
B		4.30	4.50	R2		0.15TYP	
B1		6.30	6.50	θ1		12° TYP4	
C		0.95	1.05	θ2		12° TYP4	
C1		0.127 TYP		θ3		0° ~ 7°	
C2		0.39	0.49				

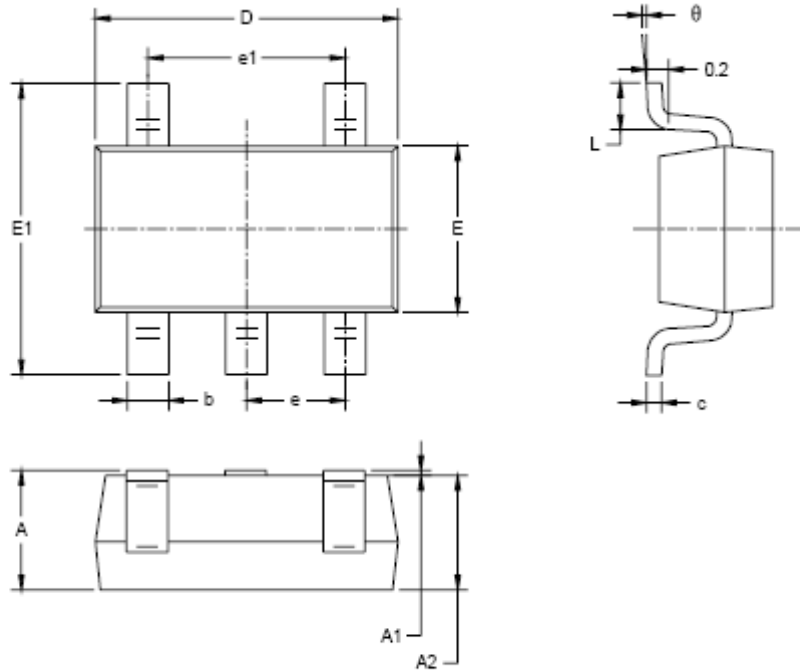
**SOT23-5**

Symbol	Dimensions In Millimeters		Dimensions In Inches	
	MIN	MAX	MIN	MAX
A	1.050	1.250	0.041	0.049
A1	0.000	0.100	0.000	0.004
A2	1.050	1.150	0.041	0.045
b	0.300	0.500	0.012	0.020
c	0.100	0.200	0.004	0.008
D	2.820	3.020	0.111	0.119
E	1.500	1.700	0.059	0.067
E1	2.650	2.950	0.104	0.116
e	0.950 BSC		0.037 BSC	
e1	1.900 BSC		0.075 BSC	
L	0.300	0.600	0.012	0.024
$\theta$	0°	8°	0°	8°

**SC70-5**

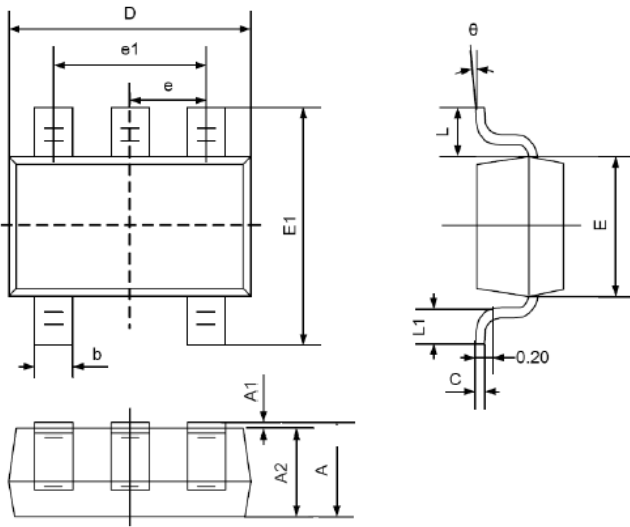

Symbol	Dimensions In Millimeters		Dimensions In Inches	
	Min	Max	Min	Max
A	0.900	1.100	0.035	0.043
A1	0.000	0.100	0.000	0.004
A2	0.900	1.000	0.035	0.039
b	0.150	0.350	0.006	0.014
C	0.080	0.150	0.003	0.006
D	2.000	2.200	0.079	0.087
E	1.150	1.350	0.045	0.053
E1	2.150	2.450	0.085	0.096
e	0.650TYP		0.026TYP	
e1	1.200	1.400	0.047	0.055
L	0.525REF		0.021REF	
L1	0.260	0.460	0.010	0.018
$\theta$	0°	8°	0°	8°

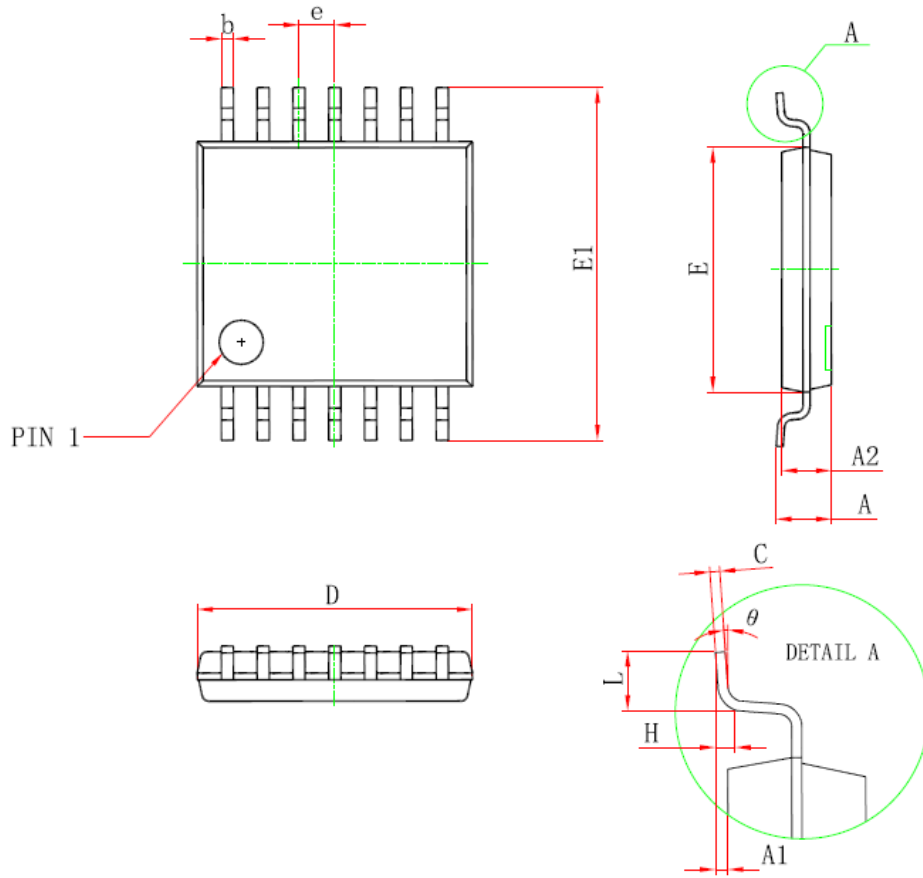
**TSSOP-14**

Symbol	Dimensions In Millimeters		Dimensions In Inches	
	Min	Max	Min	Max
D	4.900	5.100	0.193	0.201
E	4.300	4.500	0.169	0.177
b	0.190	0.300	0.007	0.012
c	0.090	0.200	0.004	0.008
E1	6.250	6.550	0.246	0.258
A		1.200		0.047
A2	0.800	1.000	0.031	0.039
A1	0.050	0.150	0.002	0.006
e	0.65 (BSC)		0.026 (BSC)	
L	0.500	0.700	0.020	0.028
H	0.25 (TYP)		0.01 (TYP)	
$\theta$	1°	7°	1°	7°

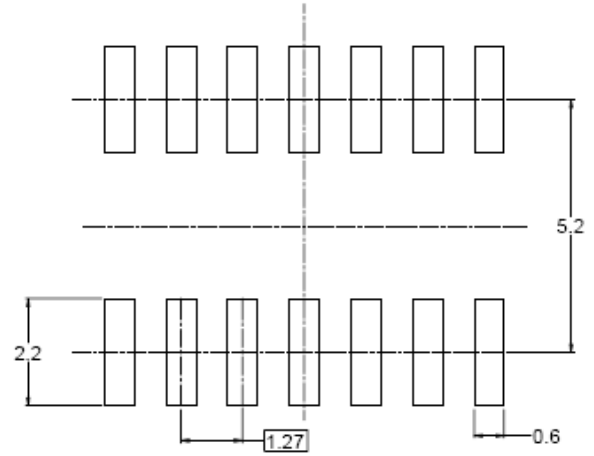
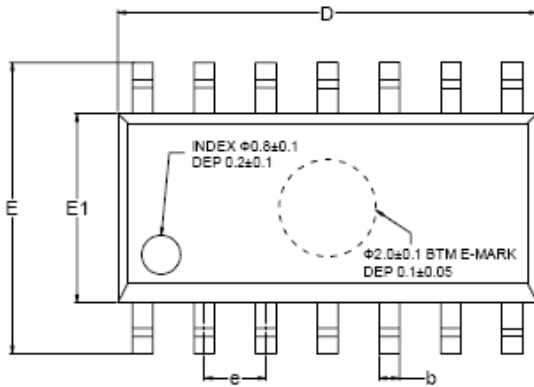
**SOP-14**

RECOMMENDED LAND PATTERN (Unit: mm)

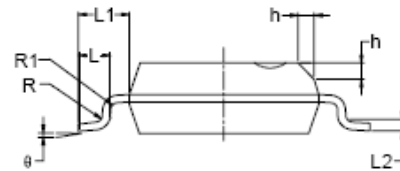
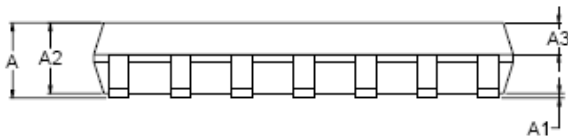

Symbol	Dimensions In Millimeters			Dimensions In Inches		
	MIN	MOD	MAX	MIN	MOD	MAX
A	1.35		1.75	0.053		0.069
A1	0.10		0.25	0.004		0.010
A2	1.25		1.65	0.049		0.065
A3	0.55		0.75	0.022		0.030
b	0.36		0.49	0.014		0.019
D	8.53		8.73	0.336		0.344
E	5.80		6.20	0.228		0.244
E1	3.80		4.00	0.150		0.157
e	1.27 BSC			0.050 BSC		
L	0.45		0.80	0.018		0.032
L1	1.04 REF			0.040 REF		
L2	0.25 BSC			0.01 BSC		
R	0.07			0.003		
R1	0.07			0.003		
h	0.30		0.50	0.012		0.020
$\theta$	0°		8°	0°		8°