

Description

The BL5617 is one channel H-Bridge driver IC, it provides integrated motor-driver solution for toys, robotics, consumer products and other low voltage or battery-powered motion control applications.

The BL5617 maximum operational voltage is 25.0V. It can supply up to 3.0A of output continuous current and 5.0A of output peak current. There is internal shutdown function for over-temperature protection and over-current protection ($I_{OCP} = 5.0\text{ A}$).

Package material is Pb-Free Product & RoHS compliant for the purpose of environmental protection and for sustainable development of the earth.

Features

- Operation voltage range up to 25.0V
- Maximum continuous current output up to 3.0A
- Low RDS(ON) for highly efficient H-bridge output
- Support PWM control
- Over current protection
- Over temperature protection
- Low standby current
- Low quiescent current
- SOP8 package

Application

- Robotics (R/C servo, Sweeping robot)
- Toys (R/C car, R/C aircraft)
- Any relevant DC motor applications.

BL5617 Package & Simplified Application

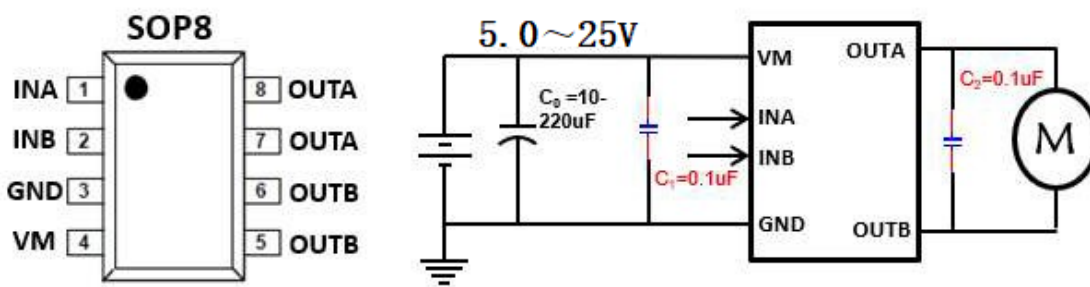

Device Information

Part No.	Package	Quantity
BL5617	SOP8	4000pcs/Reel

Pin Descriptions

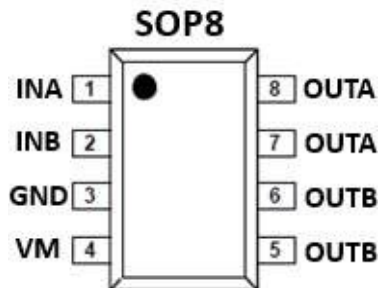

Device Marking

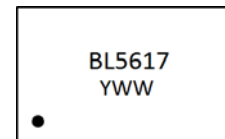

Y: year
WW:week

NO.	NAME	TYPE	DESCRIPTION
1	INA	I	Input INA
2	INB	I	Input INB
3	GND	P	Ground
4	VM	P	Power Supply for H-Bridge, Connection 10uF or bigger capacitor between VDD and GND
5	OUTB	O	Output OUTB
6	OUTB	O	Output OUTB
7	OUTA	O	Output OUTA, Connection 0.1uF between OUTA and OUTB
8	OUTA	O	Output OUTA, Connection 0.1uF between OUTA and OUTB

Absolute Maximum Ratings (T_A=25°C)

Parameter		Min.	Max.	Unit
Power Supply	V _M	-0.3	30	V
Input Logic	INA, INB	-0.3	7.0	
ESD(HBM)	V _M , INA, INB, OUTA, OUTB		4.0	kV
Operation temp.	T _J	-40	150	°C
Storage temp.	T _{stg}	-65	150	
Thermal resistance	θ _{JA}		160	°C/W

Recommended operating conditions (T_A=25°C)

Parameter		Min.	Max.	Unit
Power Supply	V _M	5.0	25.0	V
Input Logic	INA, INB	0	5.0	
Output Contiguous	I _{OUTA} , I _{OUTB}	0	3.0*	A

Notes: * Using 25mm² FR4 Signal layer PCB (1 oz) under V_M=7.2V test.

Electrical Characteristics (V_M=7.2V, T_A=25 °C, R_{LOAD}=20)

Parameter		Test Condition	Min.	Typ.	Max.	Unit
H-Bridge FETs						
ON Resistance	R _{DSON}	I _{OUT} =1.0A		0.20		Ω
INA/INB						
Input high level	V _{INH}		2.0		5.0	V
Input low level	V _{INL}		0		0.8	
Pull down resistance	R _{PD}			200	400	KΩ
Supply Current						
Standby current	I _{VM_OFF}	INA=INB=0		0	10	uA
Operation current	I _{VM_ON}			1.0	1.5	mA
Thermal Protection						
Thermal shutdown	T _{OTSD}			180		°C
Thermal shutdown	T _{HYS}			60		

Block Diagram

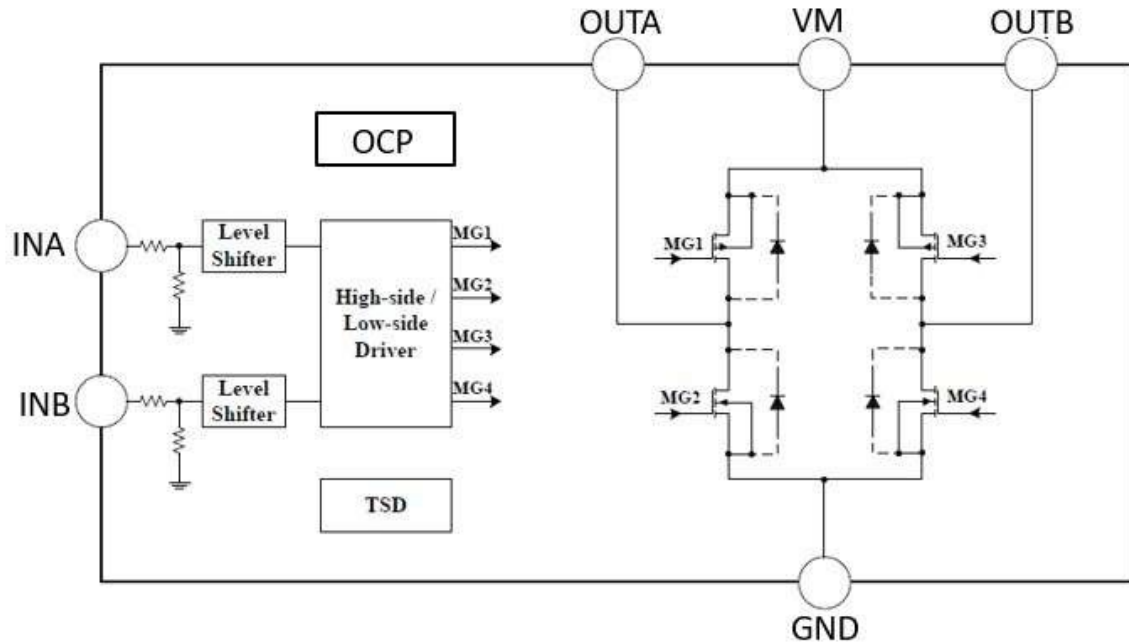

Truth Table

INA	INB	OUTA	OUTB	Mode	Supply Current
L	L	Hi-Z	Hi-Z	Stop	I_{VM_OFF}
H	L	H	L	Forward	I_{VM_ON}
L	H	L	H	Reverse	I_{VM_ON}
H	H	L	L	Brake	I_{VM_ON}

Application Notes:

1. Schematic Descriptions

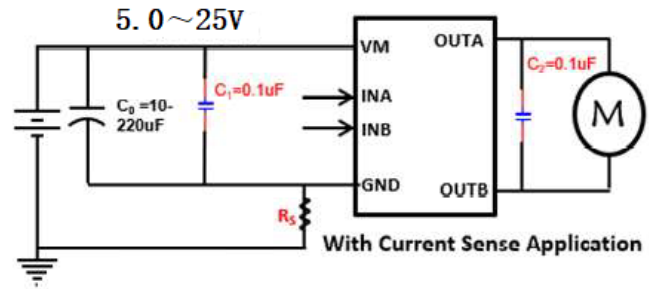
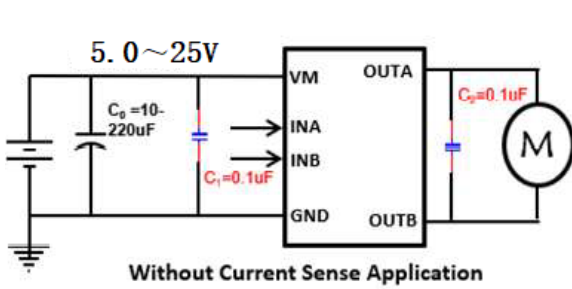

Notes :

1. This simplified schematic is only as reference in DC motor driver application.
2. C0 , C1: Power supply VM pin capacitor:
 - 1) The capacitor can reduce the power spike when the motor is in motion. To avoid the IC directly damaged by the VM peak voltage. It also can stabilize the power supply voltage and reduce its ripples.
 - 2) The C0 capacitor can compensate power when motor starts running.
 - 3) The capacitor value determines the stability of the VM during motor in motion. If the large voltage power or a heavy loading motor is used, then a larger capacitor would be needed.
 - 4) On the PCB configuration, the C0 , C1 must be mounted as close as possible to VM pin .
3. C2 : The across-motor capacitor
 - 1) The C2 capacitors can reduce the power spike of motor in start running. A 0.1μF capacitor is recommended.
 - 2) The C2 capacitor must be added to the general application.
4. RS : The sense resistor in current sense application
 - 1) Need to sense output current, the RS is recommended to added between IC GND and PCB ground.
 - 2) The C0, C1 negative terminal is recommend connection to IC GND.

2. Operating Mode Descriptions

H-Bridge basic operating mode:

A) Stop mode

Definition: When $INA=INB=L$, then $OUTA=OUTB=Hi-Z$

B) Forward mode

Definition: When $INA=H$, $INB=L$, then $OUTA=H$, $OUTB=L$

C) Reverse mode

Definition: When $INA=L$, $INB=H$, then $OUTB=H$, $OUTA=L$

D) Brake mode

Definition: When $INA=INB=H$, then $OUTA=OUTB=L$

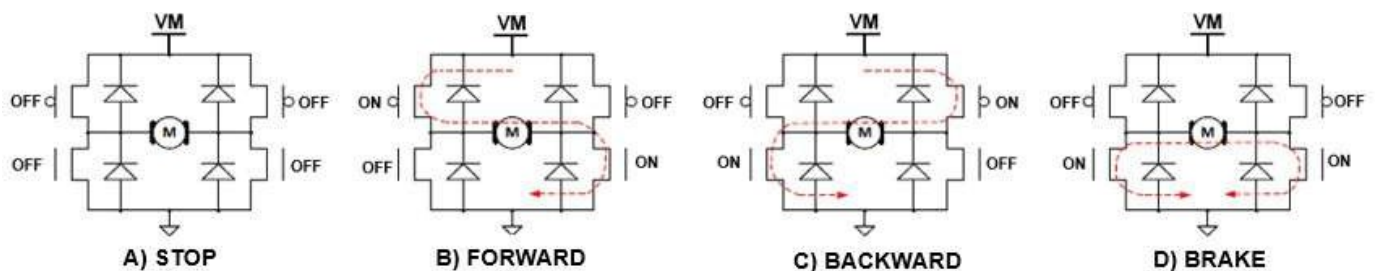

3. Protection Mechanisms Descriptions

1) Over-current protection (OCP)

While the IC conducts a large current, 5.0A (Typ.), the internal over-current protection function will be triggered. The device enters protection mode of auto-recover to avoid damaging IC and system.

2) Over-temperature protection

If the IC junction temperature exceeds 180 °C (Typ.), the internal over-temperature protection function will be triggered, partial FETs in the H-bridge are disabled, that will ensure the safety of customers' products. If the IC junction temperature falls to 120 °C(Typ.), the IC resumes automatically.

Package SOP8

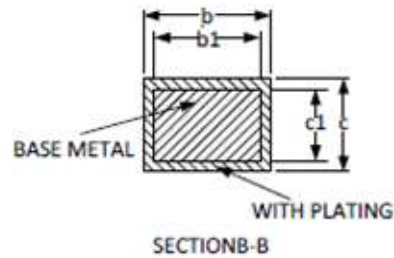
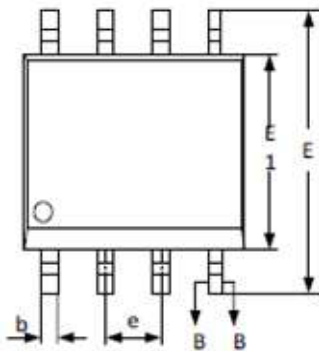
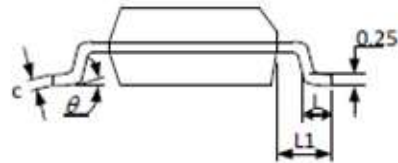
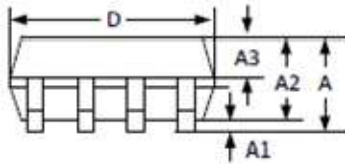

SYMBOL	MILLIMETER		
	MIN	NOM	MAX
A	--	--	1.77
A1	0.08	0.18	0.28
A2	1.20	1.40	1.60
A3	0.55	0.65	0.75
b	0.39	--	0.48
b1	0.38	0.41	0.43
c	0.21	--	0.26
c1	0.19	0.20	0.21
D	4.70	4.90	5.10
E	5.80	6.00	6.20
E1	3.70	3.90	4.10
e	1.27BSC		
L	0.50	0.65	0.80
L1	1.05BSC		
θ	0	--	8°